



# SCREW RETAINED & OVERDENTURE RESTORATIONS | VARI-CONNECT COMPONENTS

Healing Caps

 Healing Caps  
Ø 4.9mm H 4.8mm  
NM-H7101

 Healing Caps  
Ø 4.9mm H 7.0mm  
NM-H7102

 Screw  
NM-S7102

Transfers & Analog

 Open Tray  
Ø 4.9mm H 11mm  
NM-T7111

 Screw\*  
L 13mm  
NM-S7111

 Snap-On Cap for Ball Transfer  
Ø 4.8mm H 11mm  
NM-T4402

 Closed Tray  
Ø 4.9mm H 8mm  
NM-T7102

 Screw\*  
NM-S7102

 Analog  
Ø 4.9mm  
NM-T7251

Ball-Connect

 Ball-Connect  
Ø 4.9mm, H 2mm  
NM-T7262

 Ball-Connect  
Ø 4.9mm, H 3mm  
NM-T7263

 Ball-Connect  
Ø 4.9mm, H 4mm  
NM-T7264

 Metal Housing  
Ø 5mm, H 3.2mm  
NM-T3001

 Nylon Extra Soft Cap  
NM-T3002

 Nylon Soft Cap  
NM-T3003

 Nylon Standard Cap  
NM-T3004





Flat-Connect

 Flat-Connect  
Ø 4.9mm, H 3mm  
NM-T7273

 Flat-Connect  
Ø 4.9mm, H 4mm  
NM-T7274

 Metal Housing  
Ø 5.5mm, H 2.3mm  
NM-T3010

 Extra Soft Nylon Cap  
NM-T3015

 Soft Nylon Cap  
NM-T3016

 Standard Nylon Cap  
NM-T3017

 High Retention Nylon Cap  
NM-T3018

 Laboratory Cap  
NM-T3019

 Sealing Disc  
NM-T1824

Available as Set NM-T3099

Drivers for Platform Adapter

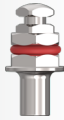
 Short Driver  
⊙ 2.0mm L 6mm  
NM-X1016

 Long Driver  
⊙ 2.0mm L 10mm  
NM-X1017

Motor Mounts for Platform Adapter

 Short Motor Mount  
⊙ 2.0mm L 20mm  
NM-X1120

 Long Motor Mount  
⊙ 2.0mm L 25mm  
NM-X1125

\*Screw - Included with the transfer above & available separately